

8 7 6 5 4 3 2 1

D

D

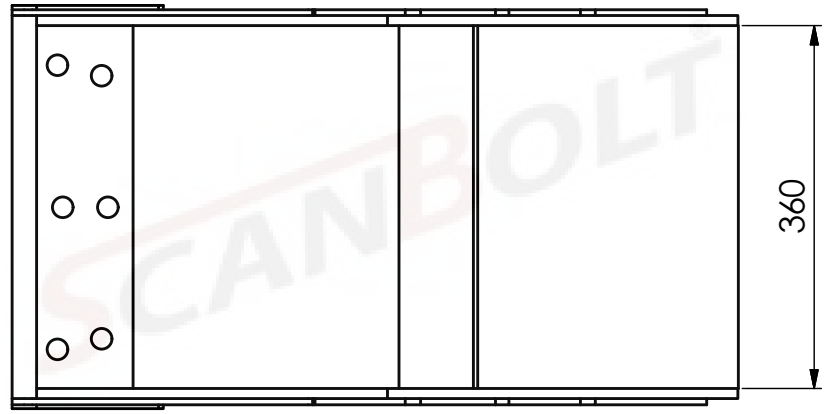
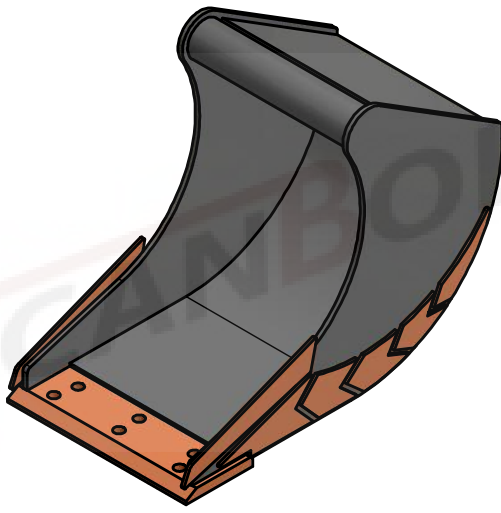

360

C

C

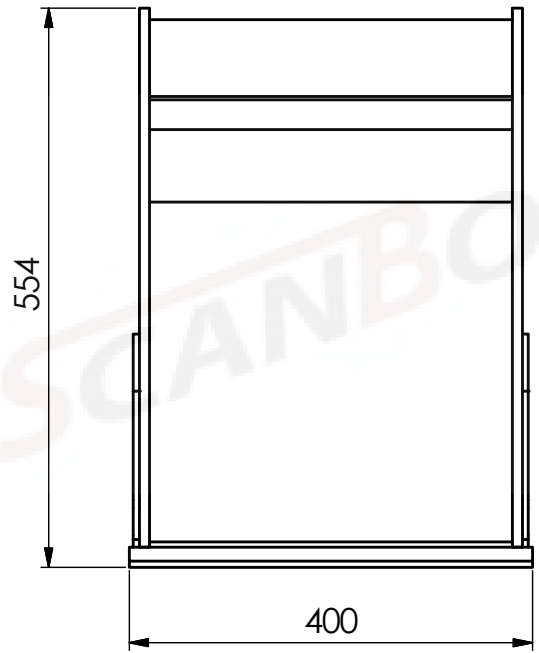

554

400

B

B

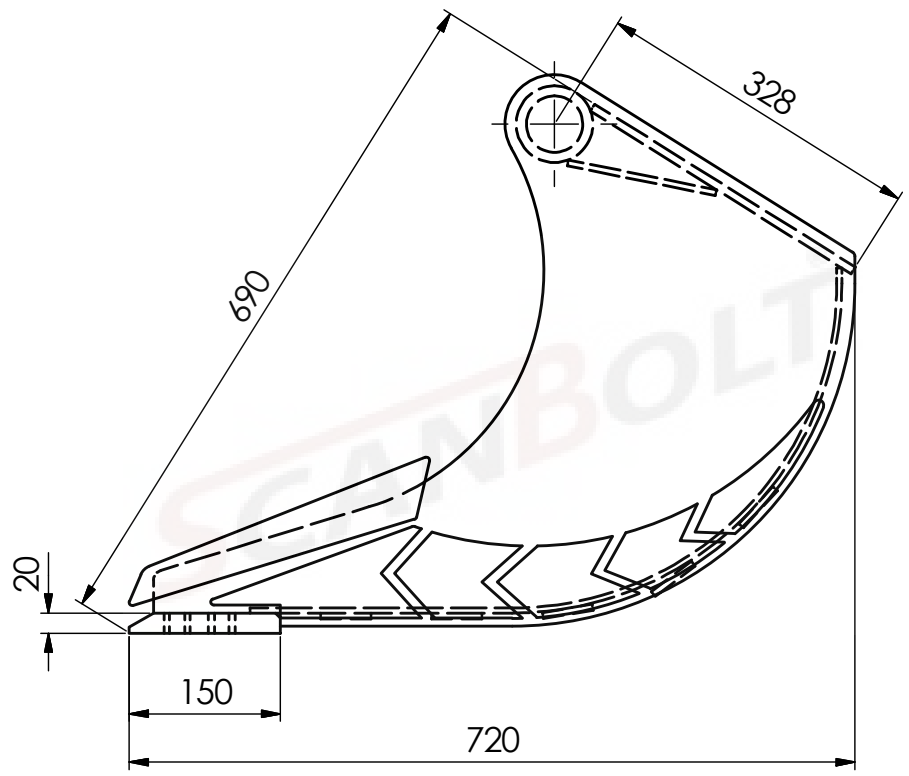

20

150





720

690

328

A

A

MATERIAL SPECIFICATION	
	ST52.3
	EN8D
	HB 400
	HB 450
	CASTALLOY STEEL

SCANBOLT®	
DESCRIPTION	40CM DIGGING BUCKET
MACHINE CLASS	3.5 - 4.9 TON
WEIGHT	72.4 Kg
HEAPED CAPACITY	87.6 LITERS

8 7 6 5 4 3 2 1